



Professional Mixing Controller

PMG-25

OWNER'S MANUAL

VESTAX CORPORATION

2-37-1 Kamiyama, Setagaya-ku, Tokyo 154-0011 Japan
Phone:03-3412-7011 Fax:03-3412-7013

VESTAX America

2750C 29th Ave Suite. 115 Hollywood, FL33020
Phone:303-766-5269 Fax:303-766-2196
E-mail:vestax-corporation@msn.com

VESTAX (Europe)Ltd.

18 st.Christophers Road, Haslemere,Surrey GU 27 1 DQ England.
Phone:(0)1428-653117 Fax:(0)1428-661021

CONGRATULATIONS!

Thank you for purchasing the VESTAX PMC-25, Professional Mixing Controller. Please read this owner's manual carefully before you start to use your mixer, so that you will fully understand all of the special features and enjoy the full use of the product.

CONTENTS

C A U T I O N	1
INPORTANT SAFEGUARDS	2
F E A T U R E S	3
F U N C T I O N S	4
PROGRAM INPUT SECTION	4
MASTER SECTION	5
MICROPHONE SECTION	6
MONITOR SECTION	6
REAR PANEL SECTION	7
CONNECTION(EXAMPLE)	8
HOW TO CHANGE THE JACK PANEL POSITION	9
BLOCK DIAGRAM	10
SPECIFICATIONS	



CAUTION

RISK OF ELECTRIC SHOCK DO NOT OPEN



**CAUTION : TO REDUCE THE RISK OF ELECTRIC SHOCK
DO NOT REMOVE COVER (OR BACK)
NO USER-SERVICEABLE PARTS INSIDE
REFER SERVICING TO QUALIFIED SERVICE PERSONNEL**



The lightning flash with arrowhead symbol, within an equilateral triangle, is intended to alert the user to the presence of uninsulated "dangerous voltage" within the product's enclosure that may be of sufficient magnitude to constitute a risk of electric shock to persons.



The exclamation point within an equilateral triangle is intended to alert the user to the presence of important operating and maintenance (servicing) instructions in the literature accompanying the appliance.

TO REDUCE THE RISK OF FIRE OR ELECTRIC SHOCK, DO NOT EXPOSE THIS APPLIANCE TO RAIN OR MOISTURE.

IMPORTANT SAFEGUARDS

READ BEFORE OPERATING EQUIPMENT

This product was designed and manufactured to meet strict quality and safety standards. There are, however, some installation and operation precautions which you should be particularly aware of.

1. Read instructions-All the safety and operating instructions should be read before the appliance is operated.
2. Retain instructions-The safety and operating instructions should be retained for future reference.
3. Heed Warnings-All warnings on the appliance and in the operating instructions should be adhered to.
4. Follow Instructions-All operating and use instructions should be followed.
5. Cleaning-Do not use liquid cleaners or aerosol cleaners. Use a damp cloth for cleaning.
6. Attachments-Do not use attachments not recommended by the product manufacturer as they may cause hazards.
7. Water and Moisture-Do not use this product near water-for example, near a bath tub, wash bowl, kitchen sink, or laundry tub, in a wet basement, or near a swimming pool, and the like.
8. Accessories-Do not place this product on an unstable cart, stand, tripod, or table. The product may fall, causing serious injury to a child or adult, and serious damage to the appliance. Use only with a cart, stand, tripod, bracket, or table recommended by the manufacturer, or sold with product. Any mounting of the appliance should follow the manufacturer's instructions, and should use a mounting accessory recommended by the manufacturer.
9. This product should never be placed near or over a radiator or heat register. This product should not be placed in a built-in installation such as a bookcase or rack unless proper ventilation is provided or the manufacturer's instructions have been adhered to.
10. Power sources-This product should be operated only from the type of power source indicated on the marking label. If you are not sure of the type of power supply to your home, consult your appliance dealer or local power company.
11. Lightning-For added protection for this product during lightning storm, or when it is left unattended and unused for long periods of time, unplug it from the wall outlet. This will prevent damage to the product due to lightning and power-line surges.
12. Overloading-Do not overload wall outlets and extension cords as this can result in a risk of fire or electric shock.
13. Object and Liquid Entry-Never push objects of any kind into this product through openings as they may touch dangerous voltage points or short-out parts that could result in a fire or electric shock. Never spill liquid of any kind on the product.
14. Servicing-Do not attempt to service product yourself as opening or removing covers may expose you to dangerous voltage or other hazards. Refer all servicing to qualified personnel.

-
15. Damage Requiring Service-Unplug this product from the wall outlet and refer servicing to qualified service personnel under the following conditions:
 - a. When the power-supply cord or plug is damaged.
 - b. If liquid has been spilled or objects have fallen into the product.
 - c. If the product has been exposed to rain or water.
 - d. If the product does not operate normally by following the operating instructions. Adjust only those controls that are covered by the operating instructions as an improper adjustment of other controls may result in damage and will often require extensive work by a qualified technician to restore the product to its normal operation.
 - e. If the product has been dropped or cabinet has been damaged.
 - f. When the product exhibits a distinct change in performance-this indicates need for service.
 16. Replacement Parts-When replacement parts are required, be sure the service technician has used replacement parts specified by the manufacturer or have the same characteristics as the original parts. Unauthorized substitutions may result in fire, electric shock or other hazards.
 17. Safety Check-Upon completion of any service or repairs to product, ask the service technician to perform safety checks to determine that the product is in proper operating condition.
 18. Carts and Stands-The appliance should be used only with a cart stand that is recommended by manufacturer.
 19. An appliance and cart combination should be moved with care. Quick stops, excessive force, and uneven surfaces may cause the appliance and cart combination to overturn.



FEATURES

1. Three-band frequency isolators are provided on PGM1 and PGM2. This allows DJs to boost / cut and eliminate individual frequency ranges for active mixing.
2. The world's first fader-type kill switch enables smooth and dynamic frequency cut-off without clicking noise.
3. The I/O panel can be placed on either the rear or top side. This feature enables the PMC-25 to be used on the table or in a rack without any extra space for the leads.
4. Both the input faders (60 mm) and cross fader (45 mm) are user replaceable. The input fader can be replaced with a rotary control for House applications.
5. One Phono and two Line inputs are provided on each program channel (PGM1, PGM2). Each input channel has a trim control for adjusting input level. A Phono / Line selectable AUX input and a Mic input are also provided.

FUNCTIONS

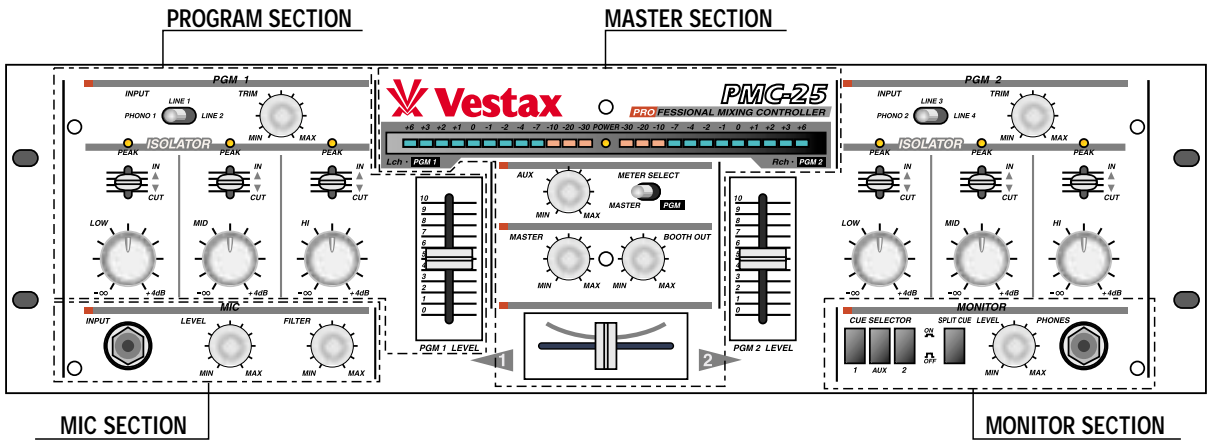

PROGRAM SECTION

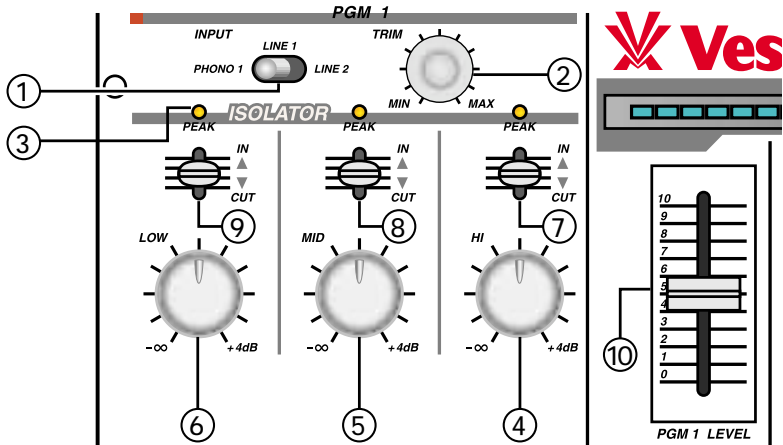

① INPUT SELECT (Input Select Switch)

Used to select input to be sent to each PGM channel.

② TRIM (Trim Control Volume)

Adjusts the Input level of each channel. For proper adjustment, please set the INPUT FADER to Maximum position then adjust TRIM so that the INPUT LEVEL METER shows around 0 dB at nominal level.

③ PEAK

Turns on when the signal of HI, MID, LOW range hits the peak.

④ HI (Isolator HI)

Cuts and boosts the high frequency range. The level is flat when this knob is set at 12 o'clock. High frequency range is boosted up to +4dB when this knob is rotated clockwise. When the knob is rotated counter-clockwise, high frequency range is cut off up to infinity level. For example, it can be used to emphasise or cut off the cymbals or high hats.

⑤ MID (Isolator MID)

Cuts and boosts the mid frequency range. The level is flat when this knob is set at 12 o'clock. Mid frequency range is boosted up to +4dB when this knob is rotated clockwise. When the knob is rotated counter-clockwise, mid frequency range is cut off up to infinity level. For example, it can be used to emphasise or cut off the vocals or guitars.

⑥ LOW (Isolator LOW)

Cuts and boosts the low frequency range. The level is flat when this knob is set at 12 o'clock. Low frequency range is boosted up to +4dB when this knob is rotated clockwise. When the knob is rotated counter-clockwise, low frequency range is cut off up to infinity level. For example, it can be used to emphasise or cut off the bass.

⑦ **HI CUT (Fader type cut switch HI)**

When this volume is set to bottom position, high frequency range is cut of completely regardless of the position of the HI level control. The HI level control knob becomes active when this volume is set to maximum (top) position.

⑧ **MID CUT (Fader type cut switch MID)**

When this volume is set to bottom position, mid frequency range is cut of completely regardless of the position of the MID level control. The MID level control knob becomes active when this volume is set to maximum (top) position.

⑨ **LOW CUT (Fader type cut switch LOW)**

When this volume is set to bottom position, low frequency range is cut of completely regardless of the position of the LOW level control. The LOW level control knob becomes active when this volume is set to maximum (top) position.

⑩ **INPUT FADER**

Used to adjust the input level of each program. Please replace with IF-25 when it is worn out, or with the optional rotary fader unit, RF-25, for house applications.

HOW TO REPLACE THE INPUT FADER

- Remove four screws, which hold the fader unit panel.
- Remove the input fader unit, IF-25.
- Carefully remove the multi-cable connector from the fader unit.
- Insert the connector to the new fader unit.
- Place the fader unit to proper position and fix it with four screws.

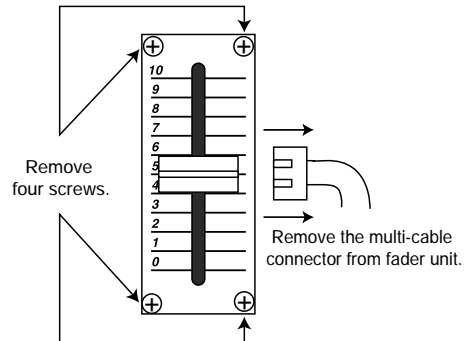

MASTER SECTION

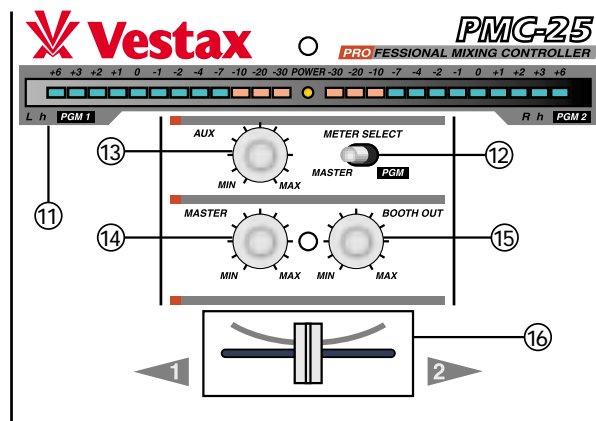

⑪ **LED LEVEL METER**

The bar graph level meters indicate the master output level (L channel and R channel) or input level of each program (program 1 and 2).

⑫ **METER SELECT**

When this switch is set to MASTER, the bar-graph meter indicates the master output level (L channel and R channel). When it is set to PGM, the left meter shows the input level of PGM1 and the right meter shows the input level of PGM2.

⑬ **AUX (AUX level volume)**

Used to adjust the Input level of AUX IN.

⑭ **MASTER (MASTER level volume)**

Adjusts the output level of LINE OUT and PA OUT.

⑮ **BOOTH OUT**

Adjusts the output level of BOOTH OUT.

⑯ **CROSS FADER**

The signal from PGM1 is output when the cross fader is set to the left side. The signal from PGM2 is heard when the cross fader is set to the right side. When the cross fader is set at centre position, both programs will be mixed and output at the same time. Please replace it with the CF-R when it is worn out.

HOW TO REPLACE THE CROSS FADER

- Remove four screws, which hold the fader unit panel.
- Remove the cross fader unit, CF-R.
- Carefully remove the multi-cable connector from the fader unit.
- Insert the connector to the new fader unit.

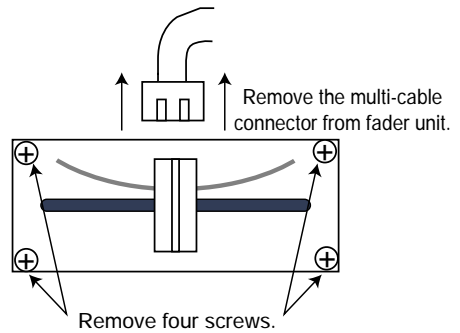

MICROPHONE SECTION

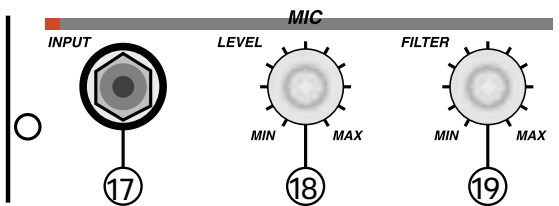

- ⑰ **INPUT (Mic Input Jack)**
Input jack for the microphone.
- ⑱ **LEVEL (Mic Level Volume)**
Adjusts the input level of the microphone.
- ⑲ **FILTER (Mic Filter Volume)**
Adjusts the cut off frequency of the microphone input. It is used to prevent low frequency noise such as breathing, vibration, etc.

MONITOR SECTION

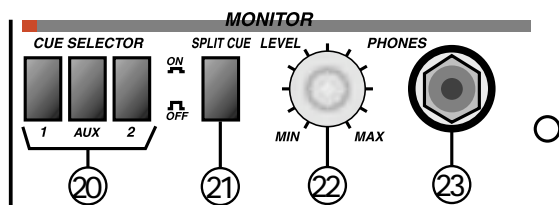

- ⑳ **CUE SELECTOR**
Used to select the cue signal to be monitored by headphones from PGM1, PGM2 or AUX.
- ㉑ **STEREO CUE (Stereo Cue ON/OFF Switch)**
When this switch is set to ON, the input signal selected by CUE SELECTOR can be monitored in stereo through headphones. When this switch is set to OFF, the master signal can be monitored through the right side of the headphone all the time, the CUE signal selected by CUE SELECTOR will be heard from the left side. This feature allows DJs to monitor current and next source simultaneously.
- ㉒ **LEVEL (Headphone Level)**
Adjust the monitor level of the headphones.
- ㉓ **PHONES (Headphone Jack)**
Used to connect the headphones. Headphones with impedance from 8~600 can be used.

REAR PANEL SECTION

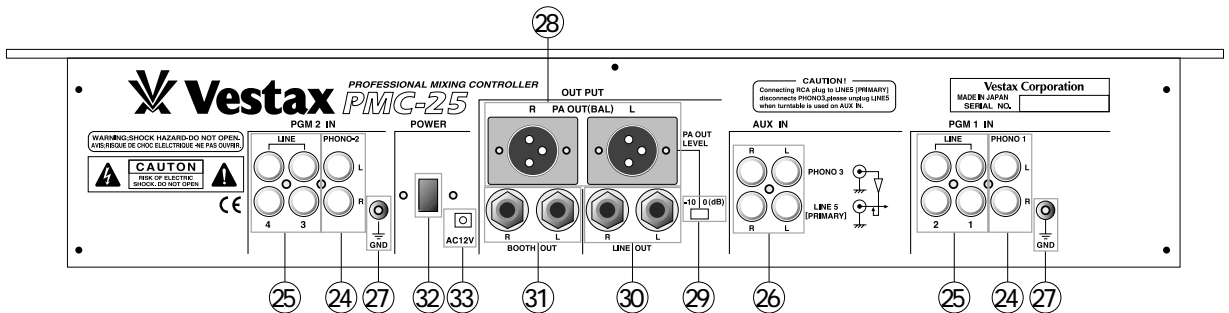

- ②④ **PHONO 1,2 [RCA PIN JACK]**
Connect turntables equipped with MM (Moving Magnet type) cartridge. The signal from the turntable is fed to the PGM channels when Phono input is selected.
- ②⑤ **LINE 1,2,3,4 [RCA PIN JACK]**
Connect the equipment with line level output (-10dB or 0dB), such as CD players, tape decks, DATs, MDs etc. The signal from line level equipment is fed to the PGM channels when Line input is selected.
- ②⑥ **AUX IN (LINE 5, PHONO 3) [RCA PIN JACK]**
Input jack for turntable and line level equipment. The signal from these jacks are fed to AUX input channel.
- ②⑦ **GND (Ground Terminal)**
Connect the ground lead from the turntable. Failure to connect a ground lead produces noise on Phono input signal.
- CAUTION**
When the line level equipment is connected to LINE 5 input jack, the input signal from PHONO 3 is disconnected and only the signal from line level equipment is fed to AUX input. Please disconnect LINE 5 when turntable is used.
- ②⑧ **PA OUT (Balanced Output) [XLR MALE, 2 PIN HOT]**
Main output jacks. Connect to the input of the power amplifier or the master console with XLR 3 pin cable.
- ②⑨ **PA OUT LEVEL (Balanced Output Level Select Switch) [-10dB/0dB]**
Used to select the output level of the PA OUT from -10dB or 0dB. Please select the level according to the input sensitivity of the power amplifier or the master console.
- ③⑩ **LINE OUT (Unbalanced Output) [1/4" INCH PHONE JACK]**
Unbalanced LINE output. Connect to the input of the power amplifier or the master console with 1/4" phone cable. PA OUT LEVEL (#29) does not effect this output.
- ③① **BOOTH OUT (Output for Monitor System) [1/4" INCH PHONE JACK]**
Connect to the input of the power amplifier of the DJ booth monitor system.
- ③② **POWER (Power Switch)**
Lights up when the power is on.
- ③③ **AC IN**
Connect the AC-12A AC Adapter. (12V AC, 1000mA)

CONNECTION EXAMPLE

Instruments connected to the PGM 2

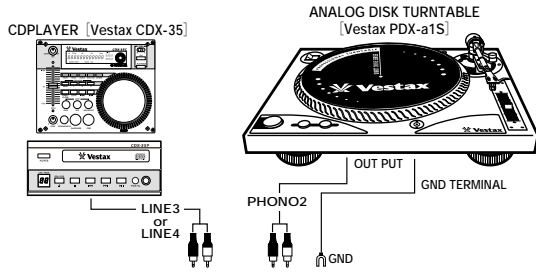

Instruments connected to the PGM 1

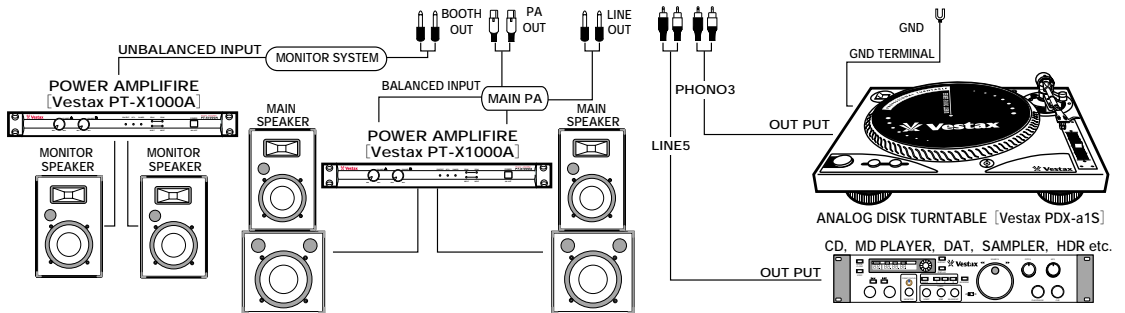
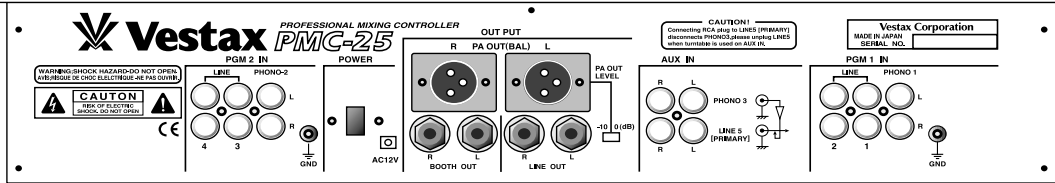
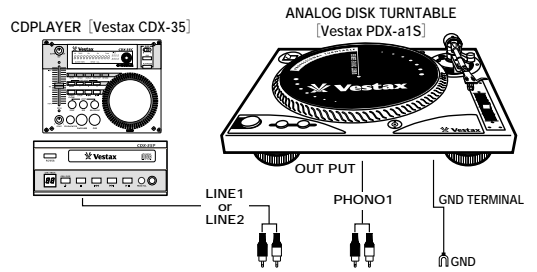

Instruments connected to the OUT PUT

Instruments connected to the AUX IN.

HOW TO CHANGE THE JACK PANEL POSITION

The I/O jack panel of the PMC-25 can be placed either on the top or back side of the unit. Please refer to following Fig.

TYPE A

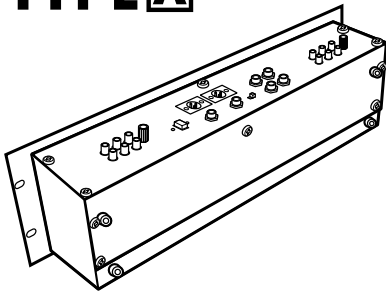

TYPE B

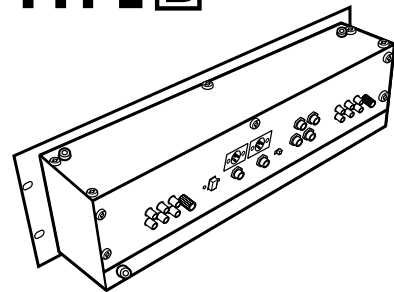

Initially, the I/O panel is placed on the top-side. In case of changing the jack panel position to TYPE B, please use following instructions.

- Remove 5 pieces of silver screw, which secure the PANEL ①.
- Remove 5 pieces of silver screw, which secure the PANEL ②.

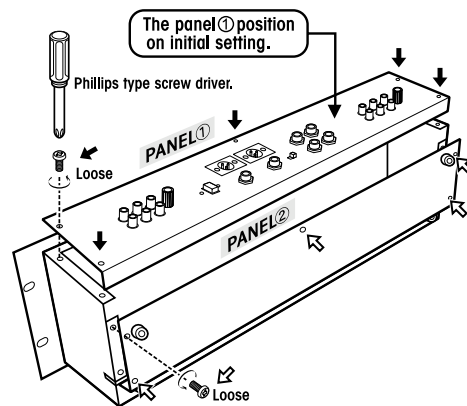

- ↓ The position of silver color five screws which is securing the panel ①.
- ↓ The position of silver color five screws which is securing the panel ②.

CAUTION

Please ensure use of the proper screwdriver (3mm Phillips type). Please hold the screwdriver upright and turn slowly. Do not use excessive force, or it may damage the screw head.

- Install the PANEL ① to the back side and secure it with 5 silver screws.
- Install the PANEL ② to the top side and secure it with 5 silver screws.

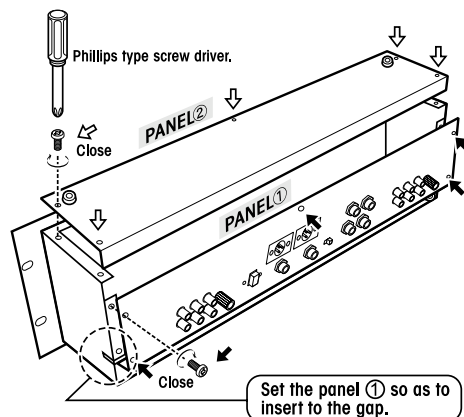

BLOCK DIAGRAM

PMC-25 BLOCK DIAGRAM

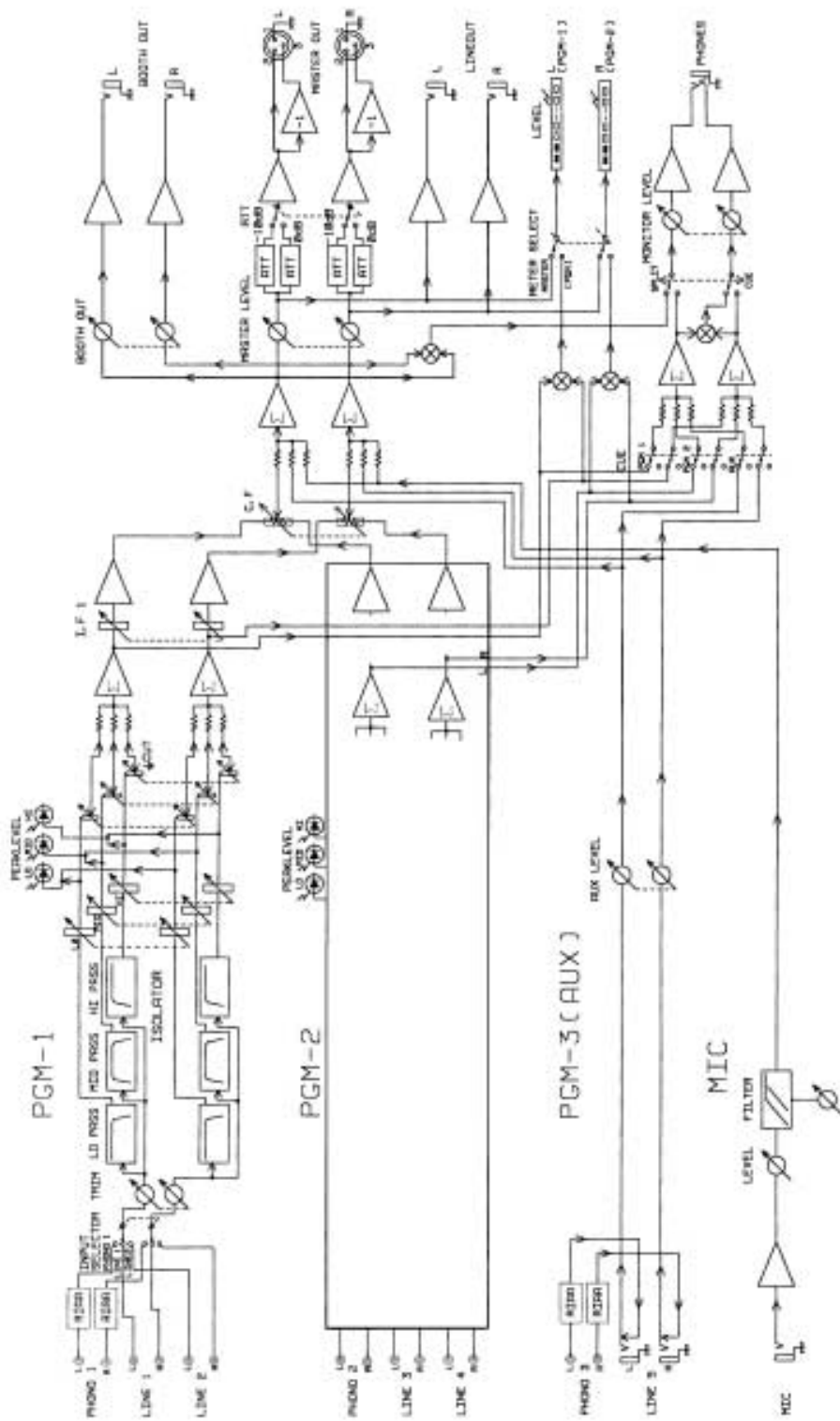



SPECIFICATION

		NOMINAL INPUT LEVEL	MAXMUM INPUT LEVEL	INPEDANCE
INPUT SECTION	MIC (1/4 INCH PHONE JACK)	-50dBv	-20dBv	3.3k Ω
	PHONO 1~3L/R (RCA PIN JACK)	-42dBv	-22dB v	56k Ω
	LINE 1~5L/R (RCA PIN JACK)	-10dBv	+14dBv	12k Ω
		RATED OUTPUT	MAXMUM OUTPUT	INPEDANCE
OUTPUT SECTION	PA OUT L/R (XLR MALE 2PIN HOT,BALANCE)	0dBv,-10dBv	+19dBv	600 Ω OVER
	LINE L/R(1/4 INCH PHONE JACK,UNBALANCE)	-10dBv	+10dBv	2k Ω OVER
	BOOTH OUT L/R (1/4 INCH PHONE OUT)	-10dBv	+14dBv	600 Ω OVER
	HEAD PHONE (1/4' PHONE JACK)		130mW	8 Ω OVER/47 Ω
FREQUENCY RESPONSE	MIC	30Hz ~ 20kHz \pm 3dB	CROSSFADER CROSSTALK	> 100dB
	LINE	20Hz ~ 20kHz \pm 1dB)	CHANNEL CROSSTALK	> 65dB
S/N RATIO	MIC	>60dB	POWER SUPPLY	AC12V ADAPTOR
	LINE	>75dB	DIMENSION (W \times H \times D)	482 \times 138 \times 112
FADER ATTENUATION		>70dB	WEIGHT	4kg