



CONTROLLER ONE

OWNER'S MANUAL

Vestax Corporation
Address: World Headquarters 1-18-6
Wakabayashi Setagaya-Ku
Tokyo Japan 154-0023
Telephone: +81.03.3412.7011
Fax: +81.03.3412.7013

CONGRATULATIONS !

Thank you for purchasing the Vestax VMC-004FX Mixing Controller. We suggest that you read through this owner's manual thoroughly so that you may enjoy the full use of this product safely and in the knowledge of all its special features and suitably applications.

CONTENTS

Features	24
Before using the CONTROLLER ONE	24
How to Assembly the CONTROLLER ONE	25
Connections and setting	27
TONE ARM SETTING	27
CONTROL LAYOUT	29
FUNCTIONS	30
NOTE MODE	32
PITCH MODE	33
MEMORY PITCH MODE	34
SETTINGS	37

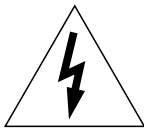

CAUTION

RISK OF ELECTRIC SHOCK DO NOT OPEN



**CAUTION : TO REDUCE THE RISK OF ELECTRIC SHOCK
DO NOT REMOVE COVER (OR BACK)
NO USER-SERVICEABLE PARTS INSIDE
REFER SERVICING TO QUALIFIED SERVICE PERSONNEL**

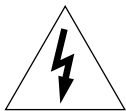

The lightning flash with arrowhead symbol, within an equilateral triangle, is intended to alert the user to the presence of uninsulated "dangerous voltage" within the product's enclosure that may be of sufficient magnitude to constitute a risk of electric shock to persons.



The exclamation point within an equilateral triangle is intended to alert the user to the presence of important operating and maintenance (servicing) instructions in the literature accompanying the appliance.

TO REDUCE THE RISK OF FIRE OR ELECTRIC SHOCK, DO NOT EXPOSE THIS APPLIANCE TO RAIN OR MOISTURE.

IMPORTANT SAFEGUARDS

READ BEFORE OPERATING EQUIPMENT

This product was designed and manufactured to meet strict quality and safety standards. There are, however, some installation and operation precautions which you should be particularly aware of.

1. Read instructions-All the safety and operating instructions should be read before the appliance is operated.
2. Retain instructions-The safety and operating instructions should be retained for future reference.
3. Heed Warnings-All warnings on the appliance and in the operating instructions should be adhered to.
4. Follow Instructions-All operating and use instructions should be followed.
5. Cleaning-Do not use liquid cleaners or aerosol cleaners. Use a damp cloth for cleaning.
6. Attachments-Do not use attachments not recommended by the product manufacturer as they may cause hazards.
7. Water and Moisture-Do not use this product near water-for example, near a bath tub, wash bowl, kitchen sink, or laundry tub, in a wet basement, or near a swimming pool, and the like.
8. Accessories-Do not place this product on an unstable cart, stand, tripod, or table. The product may fall, causing serious injury to a child or adult, and serious damage to the appliance. Use only with a cart, stand, tripod, bracket, or table recommended by the manufacturer, or sold with product. Any mounting of the appliance should follow the manufacturer's instructions, and should use a mounting accessory recommended by the manufacturer.
9. This product should never be placed near or over a radiator or heat register. This product should not be placed in a built-in installation such as a bookcase or rack unless proper ventilation is provided or the manufacturer's instructions have been adhered to.
10. Power sources-This product should be operated only from the type of power source indicated on the marking label. If you are not sure of the type of power supply to your home, consult your appliance dealer or local power company.
11. Lightning-For added protection of this product during a lightning storm, or when it is left unattended and unused for long periods of time, unplug it from the wall outlet. This will prevent damage to the product due to lightning and power-line surges.
12. Overloading-Do not overload wall outlets and extension cords as this can result in a risk of fire or electric shock.
13. Object and Liquid Entry-Never push objects of any kind into this product through openings as they may touch dangerous voltage points or short-out parts that could result in a fire or electric shock. Never spill liquid of any kind on the product.
14. Servicing-Do not attempt to service product yourself as opening or removing covers may expose you to dangerous voltage or other hazards. Refer all servicing to qualified personnel.
15. Damage Requiring Service-Unplug this product from the wall outlet and refer servicing to qualified service personnel under the following conditions:
 - a. When the power-supply cord or plug is damaged.
 - b. If liquid has been spilled or objects have fallen into the product.
 - c. If the product has been exposed to rain or water.
 - d. If the product does not operate normally by following the operating instructions. Adjust only those controls that are covered by the operating instructions as an improper adjustment of other controls may result in damage and will often require extensive work by a qualified technician to restore the product to its normal operation.
 - e. If the product has been dropped or cabinet has been damaged.
 - f. When the product exhibits a distinct change in performance this indicates need for service.

16. Replacement Parts-When replacement parts are required, be sure the service technician has used replacement parts specified by the manufacturer or have the same characteristics as the original parts. Unauthorized substitutions may result in fire, electric shock or other hazards.
17. Safety Check-Upon completion of any service or repairs to product, ask the service technician to perform safety checks to determine that the product is in proper operating condition.

18. Carts and Stands-The appliance should be used only with a cart stand that is recommended by manufacturer.
19. An appliance and cart combination should be moved with care. Quick stops, excessive force, and uneven surfaces may cause the appliance and cart combination to overturn.



FEATURES

- The CONTROLLER ONE allows you to create scales and melodies by playing single note records.
- Scales can be tuned with other instruments such as guitars and pianos with the TUNE volume.
- The memory pitch mode saves the RPM speed of the CONTROLLER ONE, which allows you to create your own original scale and performances.
- The MIDI SYNC feature synchronizes the CONTROLLER ONE's RPM speed to the MIDI NOTE signals sent from sequencers.
- 2 Operation modes, PITCH mode and NOTE mode can be changed to suite your preference and performance easily with a flick of a switch.
- Features such as the 8 KEY buttons, Pitch bend, UP button and DOWN button have been designed for playing scales and melodies.

Before using the CONTROLLER ONE

INCLUDED ITEMS

A number of parts are not attached to the CONTROLLER ONE. Please check if all items listed below are included.

- | | | |
|--|-------|--|
| <ul style="list-style-type: none"> 1 CONTROLLER ONE main unit 1 Platter 1 Slipmat 1 Head shell 1 Balance Weight | | <ul style="list-style-type: none"> 1 Shell Weight 1 EP Adaptor 2 screws (For platter) 1 Screw Driver 1 Users Manual 1 RCA cable 1 GND cable |
|--|-------|--|

How to Assembly the CONTROLLER ONE

Turntable Assembly

- (1) Place the platter on the center spindle. The platter will adjust itself to best fit over the spindle.
- (2) Adjust the positioning of a platter so that a screw goes into a screw holes.
- (3) Tighten screws using a driver and fix a platter and a main unit.
- (4) Place the slip mat on the platter.

NOTE

In case of an assembly, be careful so that a main unit and a platter do not collide strongly.
If the player is operated without fixing the screws, the platter may not rotate properly.
Do not plug into a power outlet until this unit is fully assembled and adjusted.

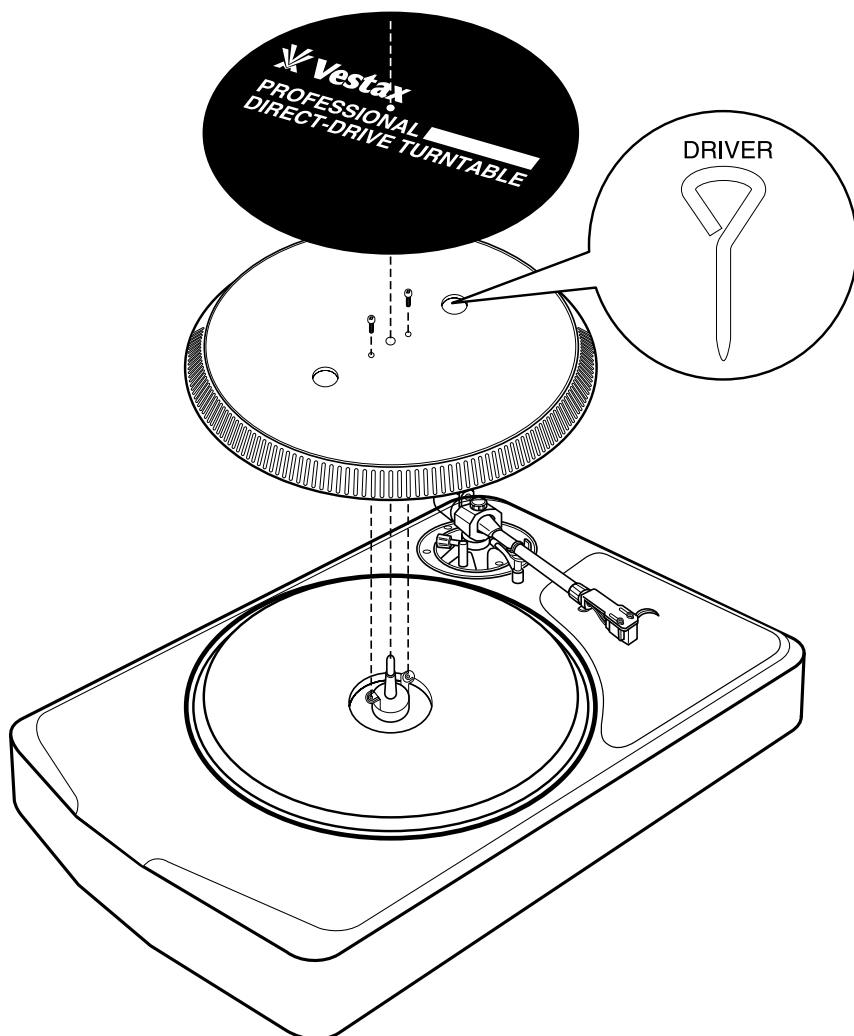

Installing the Balance Weight

From the backend of the tone arm (towards the rear panel) place the balance weight onto the shaft and turn counter clockwise. (Refer to the illustration)

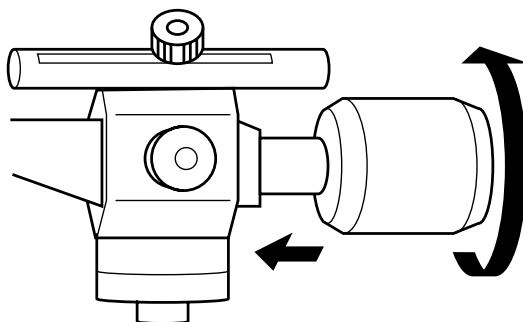

How to use the Slipmat

Place the slip mat on the platter. Then place a record on top of the slip mat. By using a slip mat, it becomes possible to stop a record board by hand during rotation of a platter or to make it reverse. Moreover, if an optional slip-sheet is set and used, it will take effect more.

Cartridge Attachment

- (1) Make sure that you follow the instructions included with your cartridge.
- (2) Connect the lead wires to the respective terminals. Industry standard cartridges come with color-coded wires. Make sure that you match these colors correctly.

Red (R+) Right Channel+
 Green (R-) Right Channel -
 White (L-) Left Channel+
 Blue (L-) Left Channel -

NOTE

If using a lightweight cartridge, we suggest the use of the shell weight enclosed.

- (3) The overhang of your cartridge needs to be adjusted to best suit the A.S.T.S tone arm. For best tracking and stylus pressure a distance of 50mm (as shown) should be set.

NOTE

To avoid premature damage to the stylus take care to avoid touching it during any adjustment(s).

- (4) Insert the head shell into the front part of the tone arm. Turn the locking ring in the direction shown below until the head shell is firmly fixed in place.



Top: Record disc side (Printed side)
 Bottom: Slip surface side

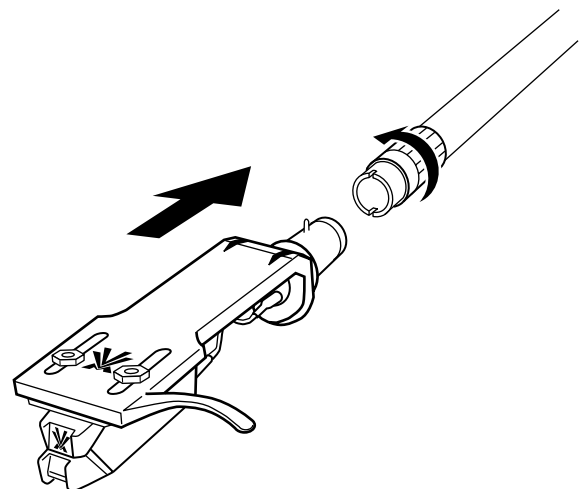
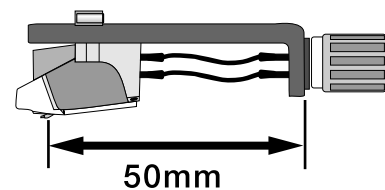
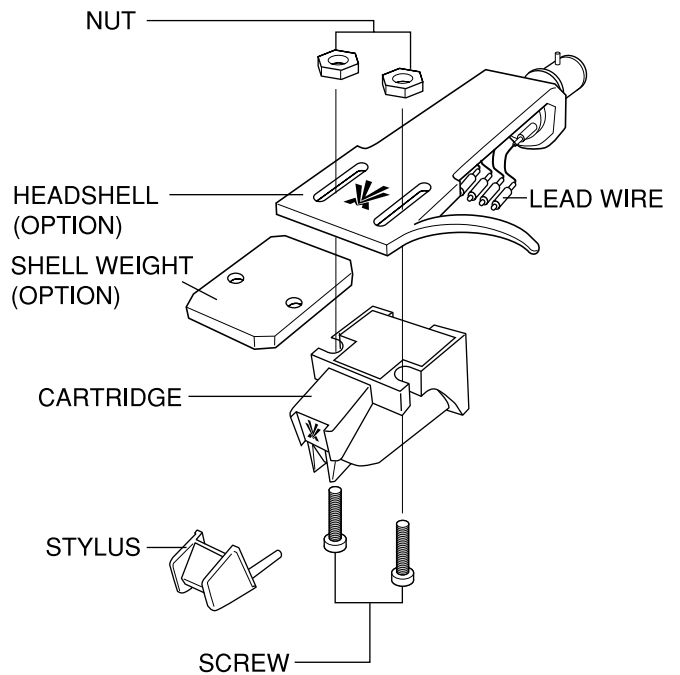

Connections and setting

Setting the CONTROLLER ONE

- Set the body on a solid horizontal surface that is not affected by external vibrations.
- Set the CONTROLLER ONE away from the speaker system as much as possible.
- Avoid sunlight, dust, moisturized places and heater when placing the CONTROLLER ONE
- Set the CONTROLLER ONE away from radios (FM/AM). It may cause noises.

POWER CONNECTION

- Connect the power cable to a power plug.

NOTE: Please make sure that the power cable is supplied with the correct voltage.

TONE ARM SETTING

Horizontal balance adjustment

1. Loosen the dynamic needle balance knob on the tone arm by unscrewing it anti-clockwise and slide it to zero. Leave the knob loose at this time.

2. Release the tone arm from the arm lock and rotate the balance weight so that it stays horizontal.

NOTE: DO NOT let the needle touch the platter or body during the adjustment.

3. Adjust the balance weight so the tone arm is set as shown in the picture.

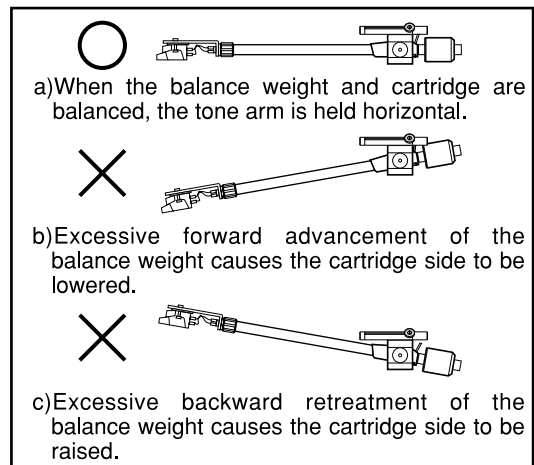
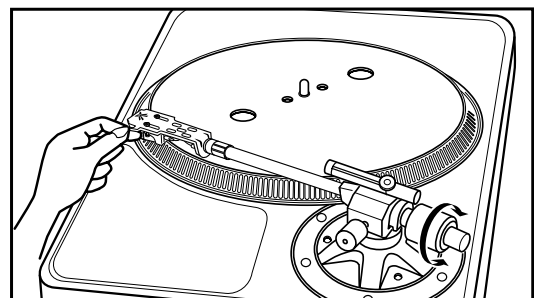
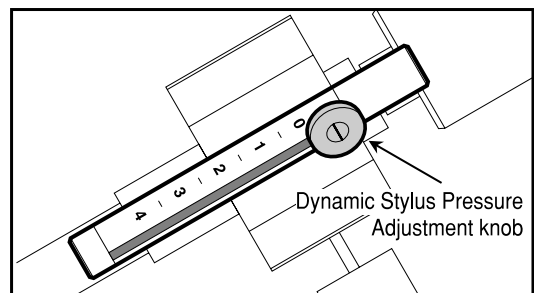

Needle pressure adjustment

4. Check if the dynamic needle pressure knob slides.

NOTE: If the balance weight moves while setting the needle pressure level, restart from setting the balance weight.

5. Slide the dynamic needle balance knob to the specified pressure level of the cartridge. ※ **NOTE:** If the needle pressure is too strong, it may cause skipping and less operating life of the needle.

6. Screw the dynamic needle balance knob clockwise to secure setting. Maximum needle pressure is 5g.

NOTE: DO NOT screw the dynamic needle knob too tight. It may cause damage.

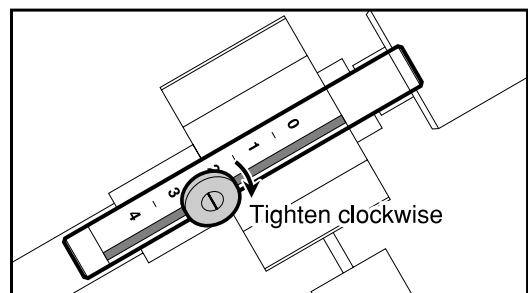
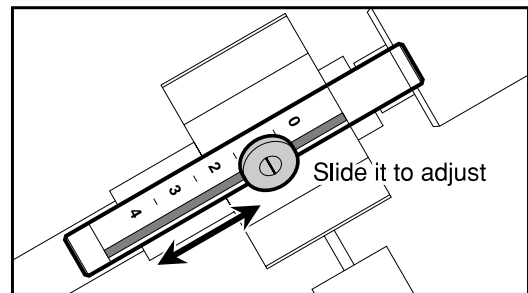
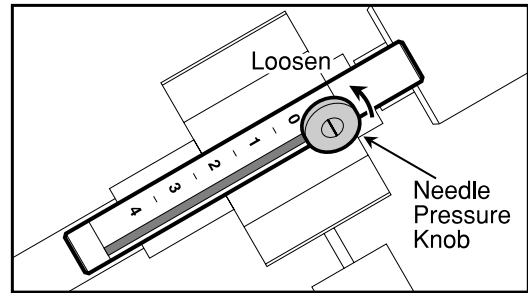

ARM HEIGHT ADJUSTMENT

- The height of the tone arm must be adjusted depending on the type of cartridge you use. The height can be adjusted easily, guided with the height scale. Maximum height is 9mm. Please refer to the cartridges manual for cartridge measurements.

- The arm height adjustment screw can be screwed with a screwdriver or a coin. Make sure the adjustment screw is screwed tightly. It may cause the needle to skip if it is loose.

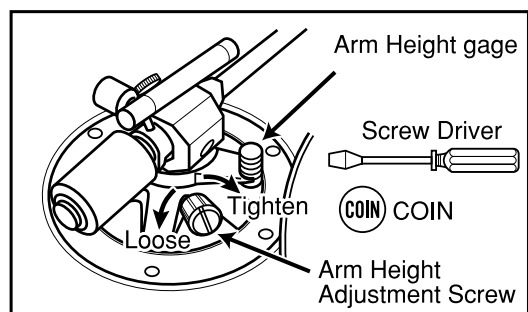
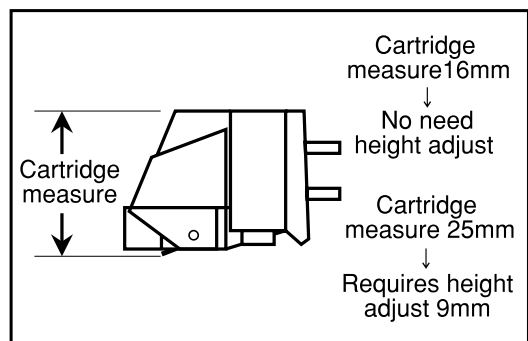

CONTROL LAYOUT

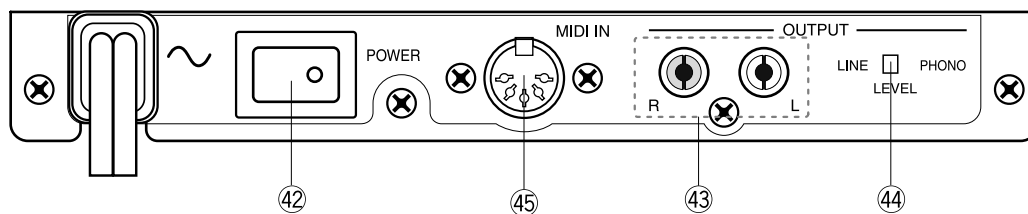
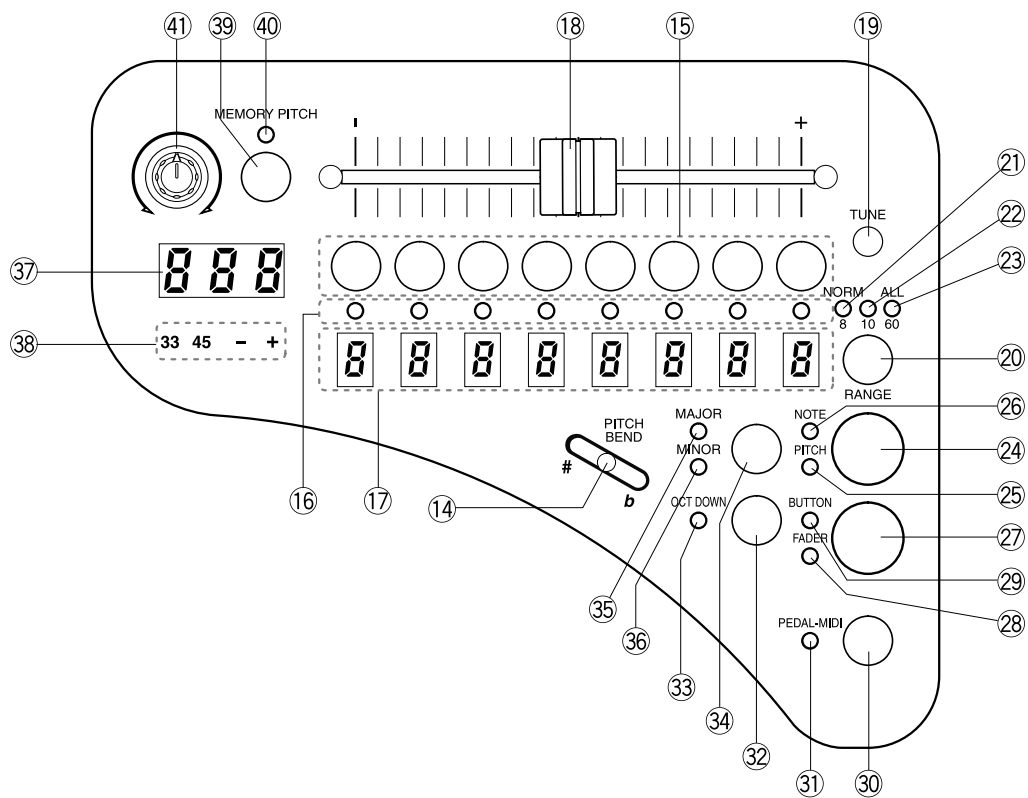
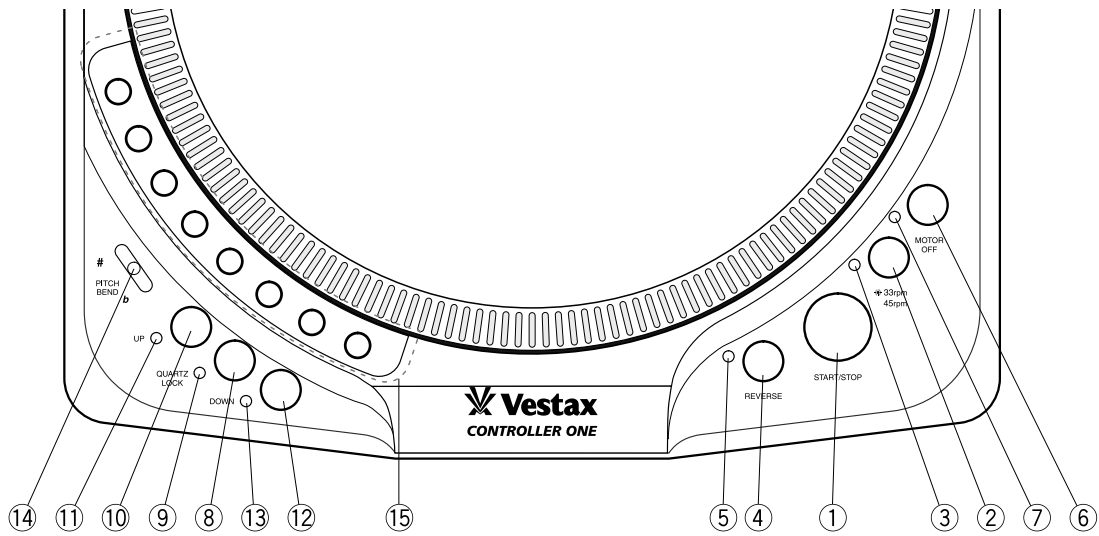

FUNCTIONS

① START/STOP SWITCH

Turns the platter rotation ON/OFF.

② 33/45rpm SWITCH

Selects the standard rotation speed of the platter.

③ 33/45rpm INDICATOR

This LED will light up when the standard rotation speed is set to 33rpm.

④ REVERSE SWITCH

This switch instantly reverses the platters rotation direction.

⑤ REVERSE INDICATOR

This LED lights up when the REVERSE SWITCH is turned ON.

⑥ MOTOR OFF SWITCH

Turns the motor OFF.

⑦ MOTOR OFF INDICATOR

This LED lights up when the motor is turned off.

⑧ QUARTZ LOCK SWITCH

NOTE MODE

The KEY switch and PITCH FADER will be invalid and the rpm speed will be held at 33rpm+/-0%.

PITCH MODE

The KEY switch and PITCH FADER will be invalid and the rpm speed will be held, selected from 33rpm or 45rpm +/-0%.

⑨ QUARTZ LOCK INDICATOR

This LED lights up when the QUARTZ LOCK is in function.

⑩ UP SWITCH

This switch raises the platter speed from 33rpm +/-0% to an octave (PTICH +100%) higher. Push the switch again to cancel the function. The PITCH FADER and KEY switch will be invalid while the UP switch is ON.

⑪ UP SWITCH INDICATOR

This LED lights up when the UP SWITCH is ON.

⑫ DOWN SWITCH

This switch slows the platter speed from 33rpm +/-0% to an octave (PTICH -50%) lower.

⑬ DOWN INDICATOR

This LED lights up when the DOWN SWITCH is ON.

⑭ PITCH BEND

NOTE MODE

Controls the platter speed from a half tone up (#) to a half tone down (b).

PITCH MODE

The adjust range is selectable from +/-1%, +/-3% and +/-6% by pushing the PITCH BEND as a button.

⑮ KEY BUTTON

Each button changes the platter speed to the rpm of the selected key.

⑯ KEY INDICATOR

Each LED lights up when an optional KEY BUTTON is pushed.

⑰ NOTE DISPLAY

Displays each KEY buttons note (rpm), PITCH MEMORY and chord settings.

⑱ PITCH FADER

Changes the platter speed. This fader is used when the (27) FADER / BUTTON select switch is set to FADER.

⑲ TUNE VOLUME

This volume knob adjusts the platter speed to tune each KEY BUTTON during NOTE MODE. The adjust range is between a half note up (#) and a half note down (b).

⑳ RANGE SWITCH

Selects the variable pitch range of the PITCH FADER.

PITCH MODE

Selectable from +/-60%, +/-10% and +/-8%. (Preset: +/-10%)

NOTE MODE

Selectable from NORMAL (8 step) and ALL (16 step) (Preset: ALL)

②1 ±8% ALL INDICATOR

This LED lights up when the PITCH FADER's pitch range is set to +/-8% or ALL.

②2 ±10% INDICATOR

This LED lights up when the PITCH FADER's pitch range is set to +/-10%.

②3 ±60% NORMAL INDICATOR

This LED lights up when the PITCH FADER's pitch range is set to +/-60% or NORMAL.

②4 PITCH / NOTE SELECT SWITCH

Selects PITCH / NOTE mode.

②5 PITCH INDICATOR

This LED lights up when the system is in PITCH mode.

②6 NOTE INDICATOR

This LED lights up when the system is in NOTE mode.

②7 FADER / BUTTON SELECT SWITCH

Selects the pitch control from the PITCH FADER and KEY BUTTON (MEMORY PITCH PLAY).

②8 FADER INDICATOR

This LED lights up when the pitch control is set to the PITCH FADER.

②9 BUTTON INDICATOR

This LED lights up when the pitch control is set to the KEY BUTTON.

③0 REMOTE SWITCH

External MIDI controllers connected to the CONTROLLER ONE control the platter speed when this switch is ON.

③1 REMOTE INDICATOR

This LED lights up when the REMOTE SWITCH is ON.

③2 Oct DOWN SWITCH

Shifts the KEY switches scale 1 octave down.

③3 Oct DOWN INDICATOR

This LED lights up when the Oct DOWN SWITCH is pushed and the KEY scale is shifted.

③4 MAJOR / MINOR SELECT SWITCH

Selects the scale for NOTE mode from MAJOR and MINOR.

③5 MAJOR INDICATOR

This LED lights up when the MAJOR / MINOR INDICATOR has selected MAJOR.

③6 MINOR INDICATOR

This LED lights up when the MAJOR / MINOR INDICATOR has selected MINOR.

③7 PITCH SEGMENT DISPLAY

Displays the pitch level in percentage.

③8 PITCH INDICATOR

Displays the basic rpm (33,45) and its +/- status.

③9 MEMORY PITCH SWITCH

Starts the function to save optional rpm speeds to each KEY switch.

④0 MEMORY PITCH INDICATOR

This LED lights up when the MEMORY PITCH function is in use.

④1 JOG DIAL

Operates the MEMORY PITCH and chord setting.

④2 POWER SWITCH

Turns the power ON / OFF.

④3 OUTPUT JACK

Outputs audio signals. Connect to a mixer or other audio devices.

④4 OUTPUT LEVEL SELECT SWITCH

Selects the audio output level from LINE and PHONO.

④5 MIDI IN JACK

MIDI external MIDI controllers.

The CONTROLLER ONE can change the rpm via PITCH mode and NOTE mode with the PITCH / NOTE SELECT SWITCH.

- The NOT MODE is designed to use a C chord single note record (33rpm) as its standard sound source.
- Notes are playable by controlling the platter speed with the PITCH FADER and KEY switches.
- The NOTE INDICATOR will light up when NOTE MODE is ON.
- An option of selecting the control from the PITCH FADER and KEY switches.
- The BUTTON INDICATOR will light up when the control is set to the KEY switches.
- The FADER INDICATOR will light up when the control is set to the PITCH FADER.
- The PITCH BEND adjusts the platter speed from # to b.
- The CONTROLLER ONE is set to NOTE mode when the power is turned ON.

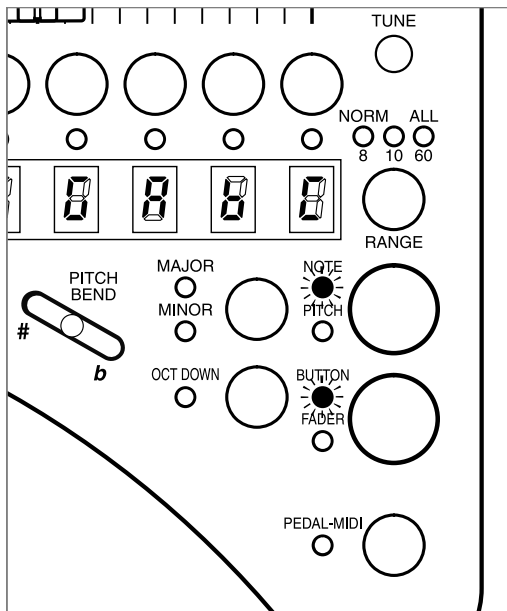

BUTTON CONTROL

- The KEY SEGMENT displays the chord of each KEY BUTTON.

NOTE: Chords displayed are based on use of a C chord single note record.

- The platter speed will change to the rpm of the chord displayed on the selected KEY BUTTON.
- The chord of each KEY BUTTON will shift a half note at every click of the JOG dial.
- Chords can be tuned with the TUNE VOLUME knob.

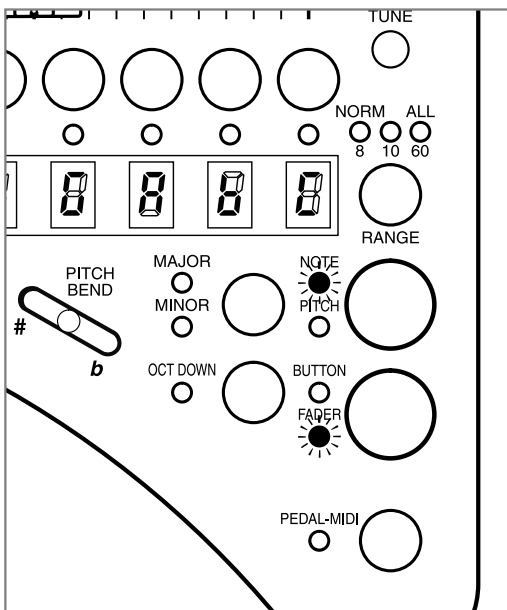

FADER CONTROL

- The KEY SEGMENT will display the chord.

NOTE: Chords displayed are based on use of a C chord single note record.

- The pitch range is selectable from NORMAL and ALL with the RANGE button. The variable pitch range of NORMAL is 1 octave and ALL is 2 octaves.
- Chords can be tuned with the TUNE VOLUME knob.

NOTE : SEGMENT DISPLAY

	=A		=A #
	=B		=B #
	=C		=C #
	=D		=D #
	=E		=E #
	=F		=F #
	=G		=G #

- The PITCH FADER controls the PITCH MODE.
- The mode will enter MEMORY PITCH PLAY MODE (ref. P16) by selecting BUTTON during PITCH MODE.
- The RANGE switch selects the variable pitch range from +/-8%, +/-10% and +/-60%.

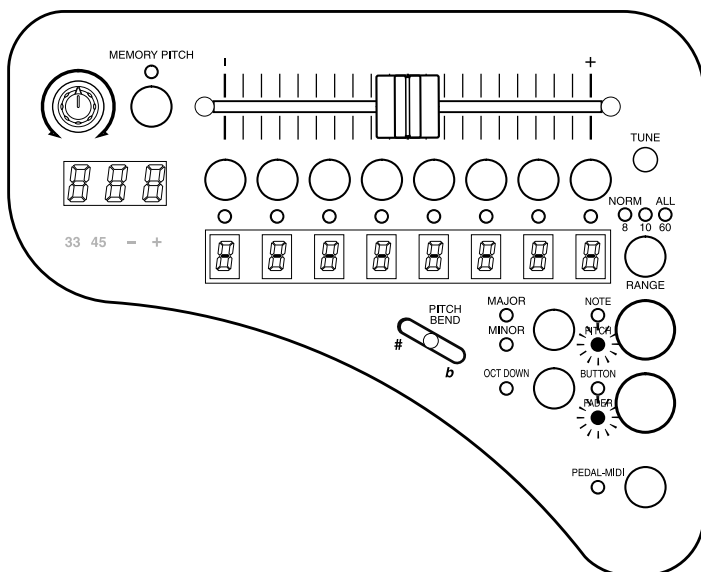

The CONTROLLER ONE can save optional rpm settings (PITCH) with the MEMORY PITCH SWITCH.

How to save an optional PITCH

- ① Select the optional rpm you want to set in NOTE MODE or PITCH MODE.
- ② Push the MEMORY PITCH SWITCH

【Setting Example】

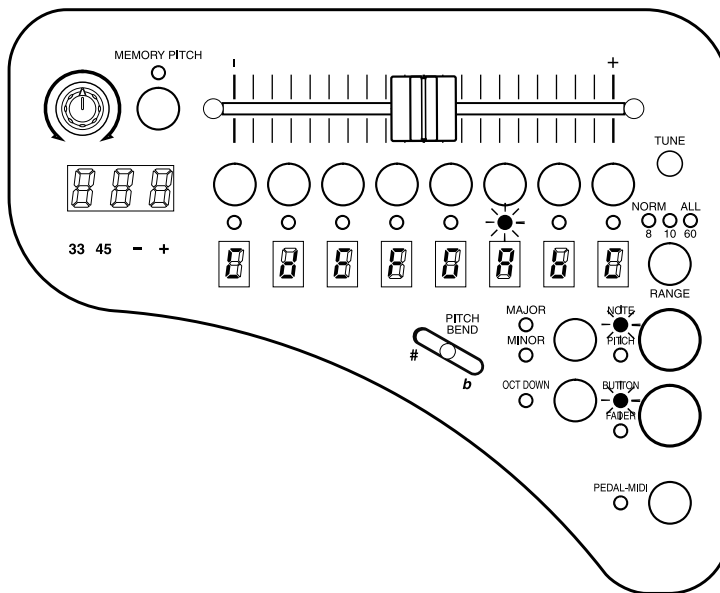

- ③ The KEY SEGMENT will blink and the BANK will show on the display. The MEMORY PITCH INDICATOR will blink.

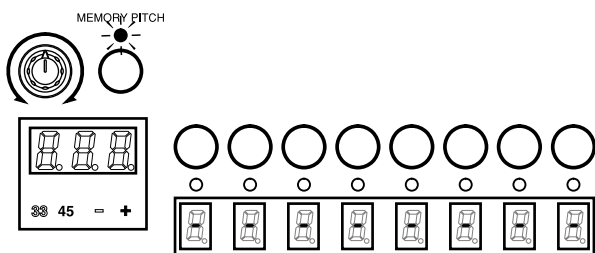

- ④ Turn the encoder to select a bank and push it to confirm. (Selectable from BANK 1~5)

NOTE : SEGMENT DISPLAY

		=BANK1			=BANK4
		=BANK2			=BANK5
		=BANK3			

⑤ The KEY SEGMENT will blink the selected BANK and the mode will be ready to save (delete) it. Each buttons saving condition will be displayed.

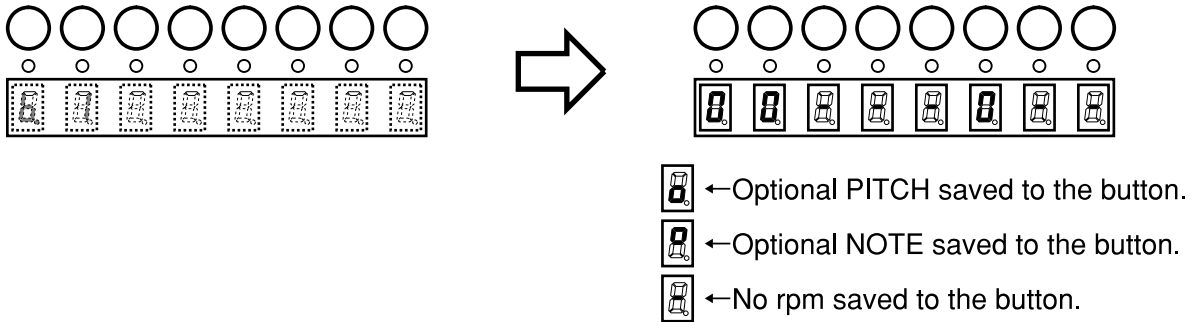

⑥ Check if the button you want to save is empty, and push it to execute.

NOTE: Previous setting must be deleted before saving a new rpm speed.

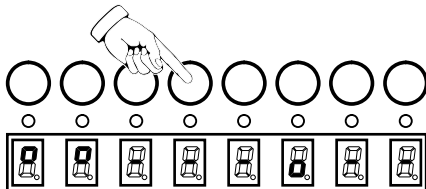

⑦ The buttons display will change when the settings are saved. (Completed)



⑧ Push the MEMORY PITCH SWITCH to cancel the MEMORY PITCH mode.

How to delete a saved PITCH

⑨ Push the button you want to delete for more that 1.5 seconds after procedure 5.

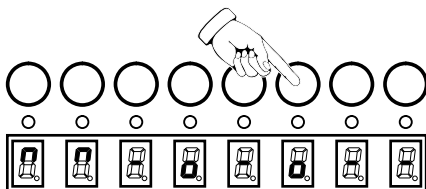

⑩ The buttons display will change when the saved rpm is deleted. (Completed)



⑪ Push the MEMORY PITCH SWITCH to cancel the MEMORY PITCH mode.

How to operate the saved PITCH

⑫ Select PITCH mode with the PITCH / NOTE SELECT SWITCH.

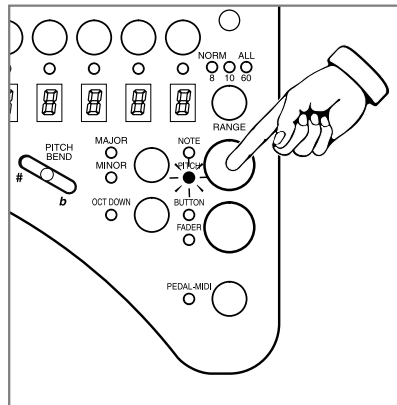

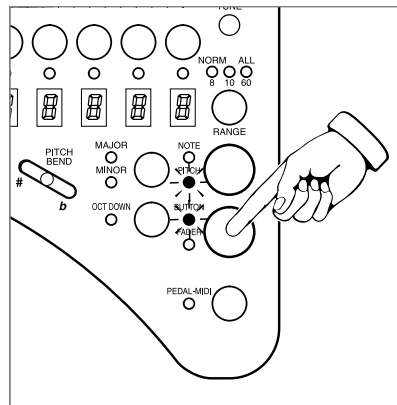

⑬ Select BUTTON with the FADER / BUTTON SELECT SWITCH.



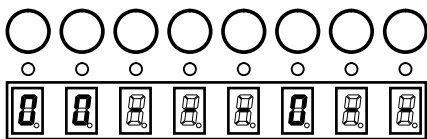









⑭ The rpm speed saved in MEMORY PITCH mode will be assigned to each KEY BUTTON.
No rpm speed saved.



-  ← When the RPM of PITCH is saved to the button
-  ← When the RPM of NOTE is saved to the button
-  ← When the RPM is NOT saved to the button

NOTE : SEGMENT DISPLAY

-   =BANK1   =BANK4
-   =BANK2   =BANK5
-   =BANK3

SETTINGS

The encoder can change / adjust chords, **KEY BUTTONS**, direction of the **PITCH BEND** and the **KEY BUTTON** assignment.

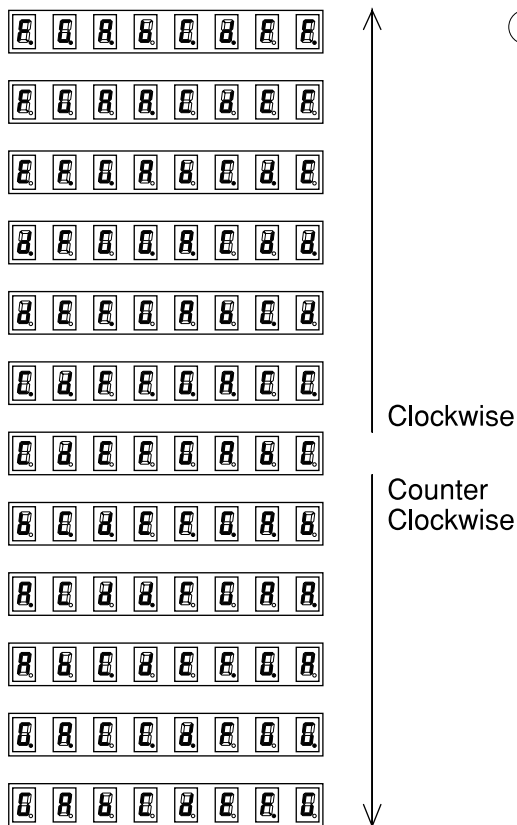

NOTE Setting

- Select NOTE mode.
- Rotate the encoder to shift each KEY buttons note. The note display will display the note of when a single note record is played. The setting range is a shown in the picture.

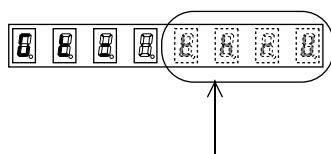
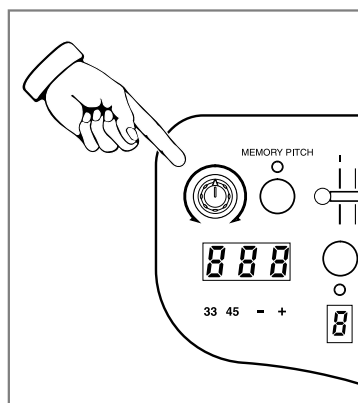

Blinks displaying either THROUGH or GATE. The selection changes by rotating the encoder.

← THROUGH

← GATE

KEY BUTTON setting

- Select button control.
- The KEY SEGMENT will display as it shows in the left picture when the encoder is rotated.
- Rotate the encoder to change the BUTTON(s) operation mode from GATE to THROUGH.

※GATE= Momentary type. The sound is played while the button is pushed.

※THROUGH= Alternate type. The sound continues to play after the button is pushed.

- Select either THROUGH or GATE and push the encoder to execute the setting.

Blinks displaying either THROUGH or GATE. The selection changes by rotating the encoder.

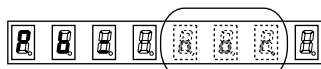

Blinks displaying either NORMAL or REVERS. The selection changes by rotating the encoder.

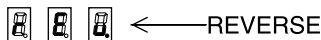
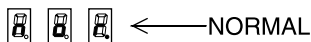

The platter rotates as printed on the body.

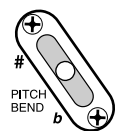

The platter rotates opposite to as printed on the body.

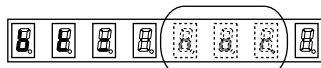

Blinks displaying either NORMAL or REVERS. The selection changes by rotating the encoder.

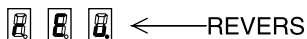
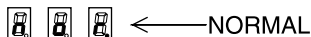

PITCH BEND

- The KEY SEGMENT displays as shown in the left picture after executing the KEY BUTTON setting.
- The display switches from NORMAL to REVERS by rotating the encoder.
- The pitch bends direction of # (+) and b (-) become opposite.
- Select the direction and press the encoder to execute the setting.
- The system moves on to the next setting.

KEY BUTTON ORDER

- Select BUTTON CONTROL
- The display switches from NORMAL to REVERS by rotating the encoder after setting the PITCH BEND.
- The order of the KEY BUTTONS on the front side of the CONTROLLER ONE reverse.
- Select the order and push the encoder to execute the setting.
- The settings are all completed.

NOTE: If the PITCH FADER is the selected PITCH control in each mode, the PITCH BEND will be the only setting adjustable.

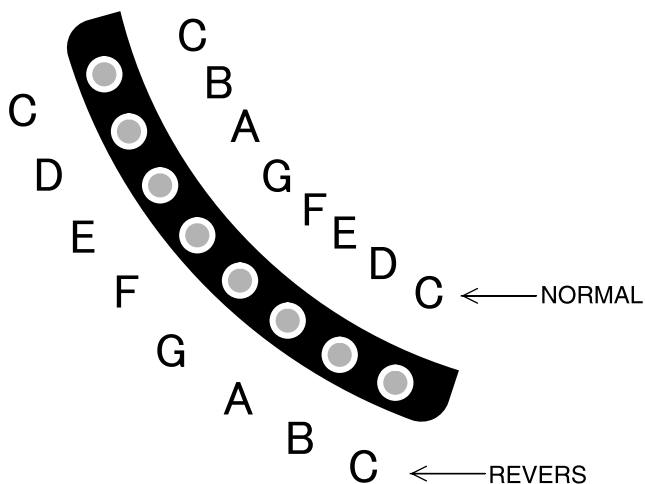

The MIDI MODE activates when the REMOTE switch is turned ON, allowing external MIDI controllers to control the CONTROLLER ONE's platter speed.

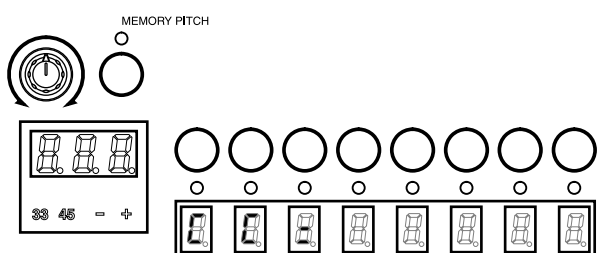
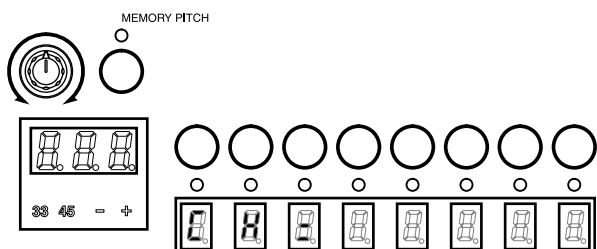

MIDI CHANNEL setting

Push the encoder (REMOTE switch ON) to enter the KEY BUTTON setting (ref. SETTINGS). Push again to enter the PITCH BEND settings and then push again to enter the MIDI channel settings. The display will show as in the left picture.

CONTROL CHANGE setting

The mode enters CONTROL CHANGE setting after MIDI CHANNEL setting. The display will show as in the left picture.

Once the CONTROL CHANGE setting is finished the mode enters KEY BUTTON ORDER and then completes the MIDI MODE setting.

MIDI Implementation Chart

FUNCTION		SEND	RECEIVE	NOTE
BASIC CHANNEL	POWER ON ADJUSTABLE	X X	1 1-16	
MODE	POWER ON MESSAGE SUBSTITUTE	X X * * * * *	MODE4 (M21) X	
NOTE NUMBER	SCALE	X * * * * *	37-83 43-78	
VELOCITY	NOTE ON NOTE OFF	X X	X X	
AFTER TOUCH	KEY SEPARATE CHANNEL SEPARATE	X X	X X	
PITCH BEND		X	○	
CONTROL CHANG	0-31 32-63	X	○ *1	PITCH CONTROL 0-31 LOWER 7bit
PROGRAM CHANGE	ADJUST RANGE	X * * * * *	X	
EXCLUSIVE		X	X	
COMMON	SONG POSITION SONG SELECT TUNE	X X X	X X X	
REAL TIME	CLOCK COMMAND	X X	X X	
OTHER	LOCAL ON/OFF ALL NOTE OFF ACTIVE SENSING RESET	X X X X	X X ○ X	
	*1	ADJSUTABLE POWER ON 4 (FOOT TYPE)		

MODE1 : OMNI ON, POLYPHONIC
MODE3 : OMNI OFF, POLYPHONIC

MODE2 : OMNI ON, MONOPHONIC
MODE4 : OMNI OFF, MONOPHONIC

○: CAN
X: CANNOT

